

BFL 914

For mobile machinery

46.2 - 129.9 kW | 61.9 - 174.2 hp at 2500 min⁻¹ | rpm

EU Stage II / US EPA Tier 2

- Air-cooled 3 to 6-cylinder naturally aspirated engines in inline arrangement.
- 4 and 6 cylinder engines also with turbocharging and optional electronic engine control (EMR) for easy integration into electronic equipment control and monitoring.
- The 6 cylinder engine with turbocharging is also available with charge air cooling.
- Easy, inexpensive installation due to minimum weight and small installation space.

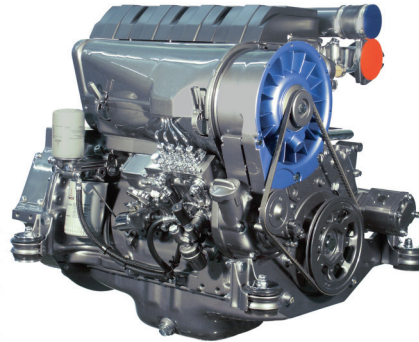

- Low noise emissions due to acoustically optimized components with very smooth running and high durability.
- The robust engine design allows worldwide operation even with high sulphur fuels.
- Highly efficient injection and combustion system ensures optimum engine performance at low consumption.
- Best cold starting performance even under extreme conditions.

Technical data

Engine type		F3L 914	F4L 914	F5L 914	F6L 914
No. of cylinders		3	4	5	6
Bore/stroke	mm in	102/132 4.02/5.2	102/132 4.02/5.2	102/132 4.02/5.2	102/132 4.02/5.2
Displacement	l cu in	3.2 197	4.3 263	5.4 329	6.5 395
Nominal speeds	min ⁻¹ rpm	2500	2500	2500	2500

Engine type		F3L 914	F4L 914	F5L 914	F6L 914
Power output as per ISO 14396 ¹⁾	kW hp	46.2 61.9	61.5 82.4	74.9 100.4	92.2 123.6
at speed	min ⁻¹ rpm	2500	2500	2500	2500
Max. torque	Nm lb/ft	202 149	270 199	333 246	400 295
at speed	min ⁻¹ rpm	1500	1500	1500	1500
Minimum idling speed	min ⁻¹ rpm	650	650	650	650
Specific fuel consumption ²⁾	g/kWh lb/hph	215 0.35	215 0.35	215 0.35	217 0.36
Weight as per DIN 70020 Part 7A ³⁾	kg lb	277 611	307 677	380 838	430 948

1) Power data without deduction of fan power.

2) Best point consumption refers to diesel with a density of 0.835 kg/dm³ at 15°C.

3) Without starter/alternator, cooler and fluids but with flywheel and flywheel housing.

The data on this data sheet are for information purposes only and are not binding values. The data in the quotation is definitive.

Torque curve

F3L 914 - 46.2 kW|61.9 hp

F4L 914 - 61.5 kW|82.4 hp

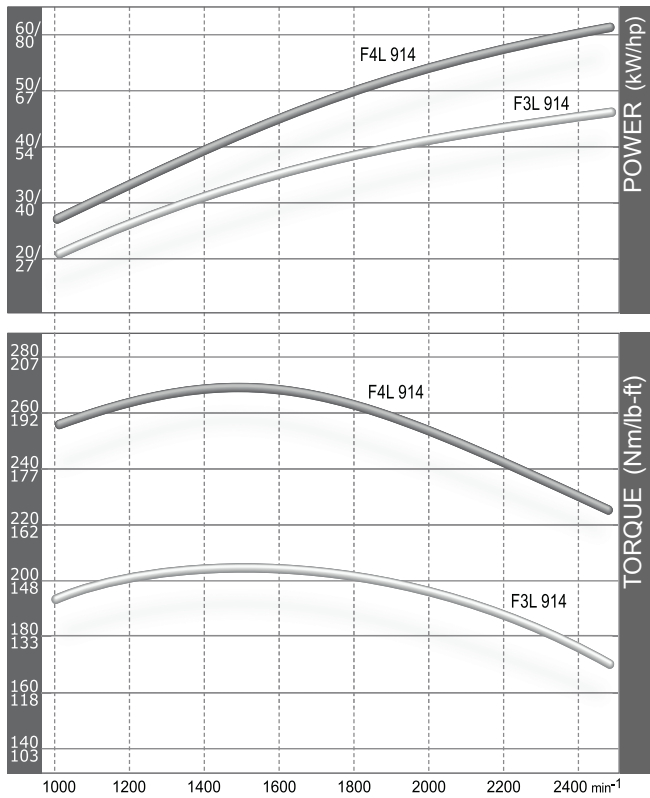

F5L 914 - 74.9 kW|100.4 hp

F6L 914 - 92.2 kW|123.6 hp

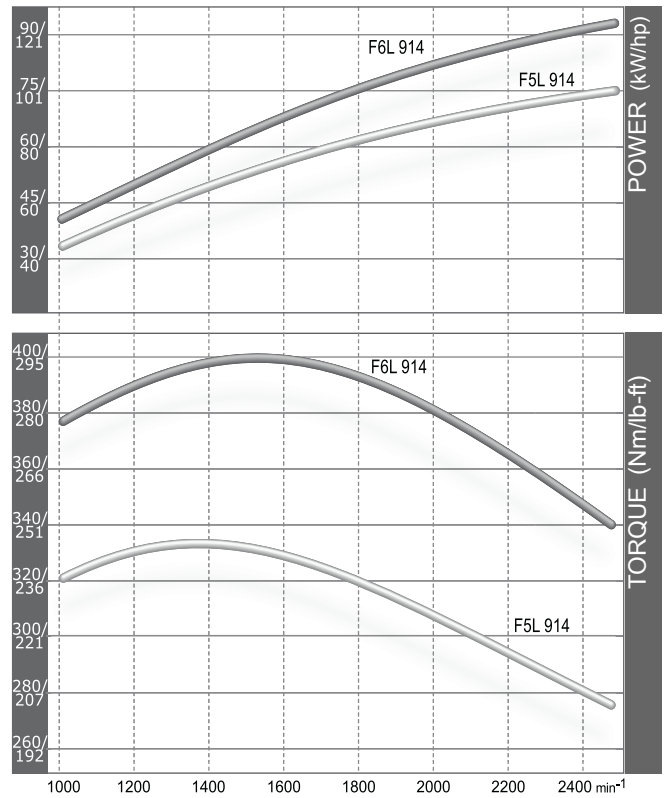

Dimensions

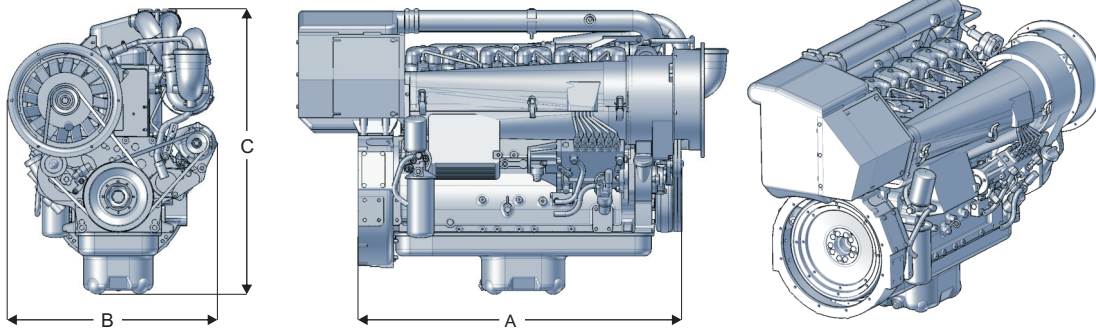

		A	B	C
F3L 914	mm in	708 28	646 25	802 32
F4L 914	mm in	838 33	646 25	799 31
F5L 914	mm in	965 38	675 27	839 33
F6L 914	mm in	1084 43	676 27	869 34
BF4L 914	mm in	820 32	669 26	823 32
BF6L 914	mm in	1166 46	683 27	886 35
BF6L 914C	mm in	1166 46	683 27	919 36

Note: The engine dimensions and weights vary depending on the scope of delivery.

Technical data

Engine type		BF4L 914	BF6L 914	BF6L 914C
No. of cylinders		4	6	6
Bore/stroke	mm in	102/132 4.02/5.2	102/132 4.02/5.2	102/132 4.02/5.2
Displacement	l cu in	4.3 263	6.5 395	6.5 395
Nominal speeds	min ⁻¹ rpm	2500	2500	2500

Engine type		BF4L 914	BF6L 914	BF6L 914C
Power output as per ISO 14396 ¹⁾	kW hp	74.9 100.4	114.9 154.0	129.9 174.2
at speed	min ⁻¹ rpm	2500	2500	2500
Max. torque	Nm lb/ft	355 262	550 406	550 406
at speed	min ⁻¹ rpm	1600	1600	1600
Minimum idling speed	min ⁻¹ rpm	650	650	650
Specific fuel consumption ²⁾	g/kWh lb/hph	235 0.39	230 0.38	215 0.35
Weight as per DIN 70020 Part 7A ³⁾	kg lb	350 772	485 1069	510 1124

1) Power data without deduction of fan power.

2) Best point consumption refers to diesel with a density of 0.835 kg/dm³ at 15°C.

3) Without starter/alternator, cooler and fluids but with flywheel and flywheel housing.

The data on this data sheet are for information purposes only and are not binding values. The data in the quotation is definitive.

Torque curve

BF4L 914 - 74.9 kW|100.4 hp

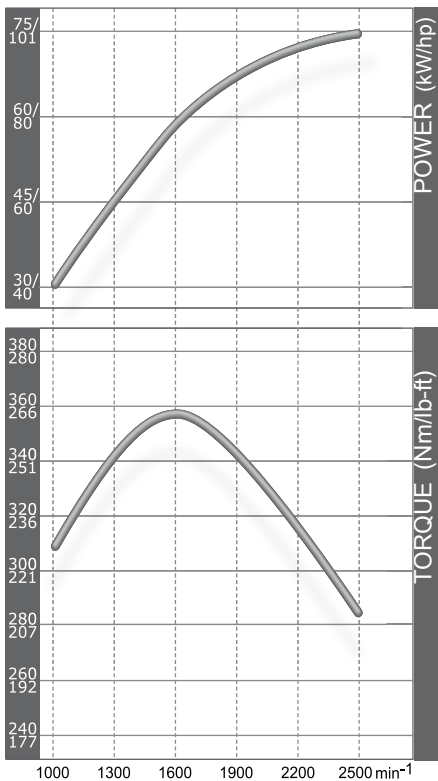

BF6L 914 - 114.9 kW|154.0 hp

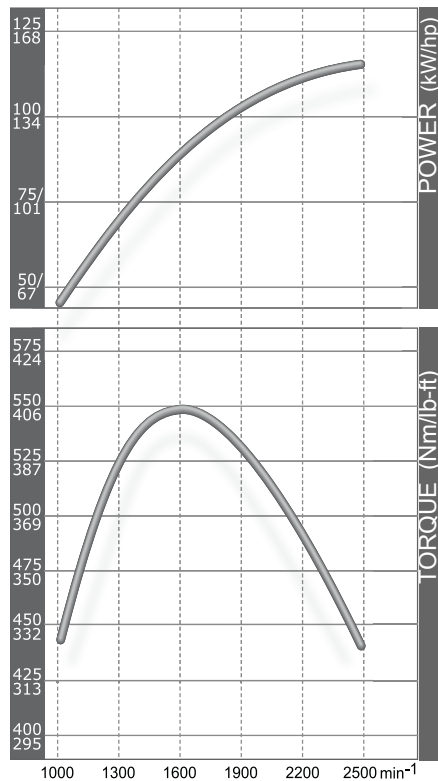

BF6L 914C - 129.9 kW|174.2 hp

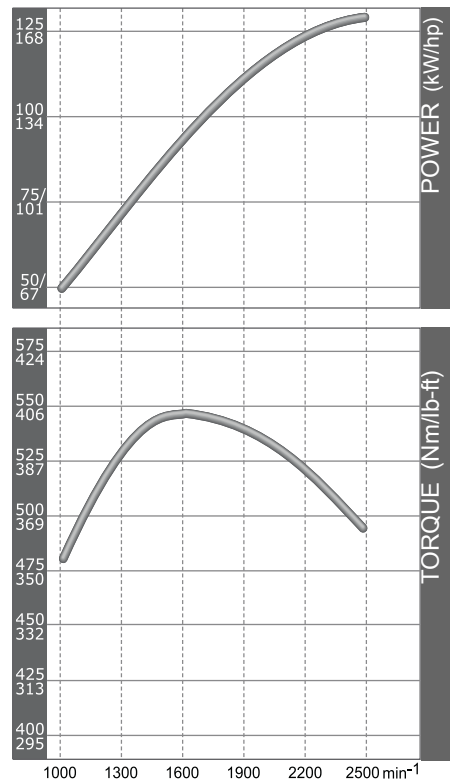

For more information please contact the DEUTZ AG Köln or the responsible sales partner.

